



XLC-60-S Series  
(Independent type)

XLC-60 Series  
(Built-in type)

IS 15885



NOTE.13



## Features

- Constant power mode output with multiple stage selectable by DIP switch or NFC setting (H-type)
- Constant voltage mode output(12/24/48V)
- Plastic housing with class II and PFC design
- Meet UL8750 Class 2 / Class P power unit
- Flicker free, complying with CE ErP directive
- Standby power consumption <0.5W
- Meet emergency lighting (EL) application
- Minimum dimming level 0.1% (DALI-2 DT6)
- Dimming functions: 3 in 1 dimming (Dim-to-off)  
DALI-2 + Push dimming
- 5 years warranty

## Applications

- Recessed Light
- Down Light
- Panel Light
- Commercial Lighting
- Decorative Lighting
- LED strip lighting
- DALI digital Lighting

## GTIN CODE

MW Search: <https://www.meanwell.com/serviceGTIN.aspx>

## Description

XLC-60 Series is a 60W with constant power and constant voltage output LED driver . It can operate from 100 ~ 305VAC and output current ranging between 900 mA to 1700 mA selectable by DIP switch or NFC setting. Thanks to high efficiency up to 90%, it is able to operate for -25°C ~90°C case temperature under free air convection. XLC-60 is designed based on latest safety regulations with 3 in 1 and DALI-2 dimming. XLC-60 can also be adjusted for brightness with a push button as a simple way dimming, so it provides more flexibility for LED Lighting application.

## Model Encoding

XLC - 60 - H -

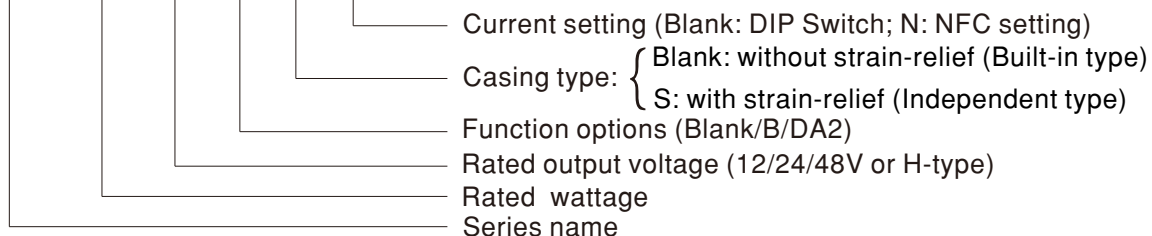

Type	Function	Note
Blank	H type output current selectable by DIP-switch or NFC setting. 12, 24, 48V Constant voltage output	In stock
B	H type output current selectable by DIP-switch or NFC with 3 in 1 dimming 12, 24, 48V Constant voltage output and built-in 3 in 1 Dimming(PWM Style output)	
DA2	H type output current selectable by DIP-switch or NFC with DALI-2 dimming 12, 24, 48V Constant voltage output and built-in DALI-2(PWM Style output)	

Note: NFC current setting is available for XLC-60-H type only.

SPECIFICATION

MODEL		XLC-60 -12- □ □	XLC-60-24- □ □	XLC-60-48- □ □
OUTPUT	DC VOLTAGE	12V	24V	48V
	DEFAULT CURRENT	5A	2.5A	1.25A
	RATED POWER	60W	60W	60W
	SETUP, RISE TIME	800ms,180ms/230VAC ,1000ms,180ms/115VAC		
INPUT	VOLTAGE RANGE	100 ~ 305VAC 155 ~400VDC		
	FREQUENCY RANGE	47 ~ 63Hz		
	POWER FACTOR	PF≥0.95/115VAC, PF≥0.95/230VAC, PF≥0.9/277VAC@full load (Please refer to "POWER FACTOR (PF) CHARACTERISTIC" section)		
	TOTAL HARMONIC DISTORTION	THD< 20%(@load ≥60%/230VAC; @load ≥75%/277VAC); THD<10%@load 100%/230VAC (Please refer to "TOTAL HARMONIC DISTORTION(THD)" section)		
	EFFICIENCY(Typ.)	86%	87%	88%
	AC CURRENT	0.75A/115VAC, 0.35A/230VAC, 0.3A/277VAC		
	INRUSH CURRENT	COLD START 15A(twidth=310µs measured at 50% Ipeak) at 230VAC; Per NEMA 410		
	MAX. No. of PSUs on 16A CIRCUIT BREAKER	25 units (circuit breaker of type B) / 36 units (circuit breaker of type C) at 230VAC		
	LEAKAGE CURRENT	<0.75mA / 277VAC		
	STANDBY POWER Note5 CONSUMPTION	Standby power consumption<0.5W (Dimming OFF, only for standard version B/DA2-type)		
PROTECTION	OVERLOAD	105~200% rated output power Protection type: Hiccup mode, recovers automatically after fault condition is removed.		
	SHORT CIRCUIT	Hiccup mode, recovers automatically after fault condition is removed		
	OVER VOLTAGE	14~17V	26~35V	52~63V
		Shut down output voltage, re-power on to recover		
	OVER TEMPERATURE	Shut down output voltage, recovers automatically after fault condition is removed		
ENVIRONMENT	WORKING TEMP.	Tcase=-25~90℃ (Please refer to "OUTPUT LOAD vs TEMPERATURE" section)		
	MAX. CASE TEMP.	Tcase=90℃		
	WORKING HUMIDITY	20 ~ 90% RH non-condensing		
	STORAGE TEMP., HUMIDITY	-40 ~ +80℃, 10 ~ 95% RH		
	TEMP. COEFFICIENT	±0.03%/℃ (0 ~ 50℃)		
	VIBRATION	10 ~ 500Hz, 2G 10min./1cycle, period for 60min. each along X, Y, Z axes		
SAFETY&EMC	SAFETY STANDARDS	UL8750(Class P), CSA C22.2 No. 250.13-12; ENEC BS EN/EN61347-1, BS EN/EN61347-2-13(EL) appendix J suitable for emergency installations(DC input 176-280VDC); BS EN/EN62384 , BIS IS15885(Part2/Sec13)(NOTE 13), GB/T19510.1, GB/T19510.213, EAC TP TC 004 approved; Design refer to AS/NZS 61347-1, AS/NZS 61347-2-13		
	DALI STANDARDS	Comply with IEC62386-101, 102, 207		
	WITHSTAND VOLTAGE	I/P-O/P:3.75KVAC		
	ISOLATION RESISTANCE	I/P-O/P:>100M Ohms / 500VDC / 25℃ / 70% RH		
	EMC EMISSION	Parameter	Standard	Test Level/Note
		Conducted	BS EN/EN55015(CISPR15) ,GB/T 17743	-----
		Radiated	BS EN/EN55015(CISPR15) ,GB/T 17743	-----
		Harmonic Current	BS EN/EN61000-3-2 , GB17625.1	Class C @load≥60%
	Voltage Flicker	BS EN/EN61000-3-3	-----	
	EMC IMMUNITY	Parameter	Standard	Test Level/Note
		ESD	BS EN/EN61000-4-2	Level 3, 8KV air ; Level 2, 4KV contact
		Radiated	BS EN/EN61000-4-3	Level 2
		EFT/Burst	BS EN/EN61000-4-4	Level 2
		Surge	BS EN/EN61000-4-5	Level 3, 1KV/Line-Line
Conducted		BS EN/EN61000-4-6	Level 2	
Magnetic Field		BS EN/EN61000-4-8	Level 2	
Voltage Dips and Interruptions		BS EN/EN61000-4-11	70% residual voltage for 10 period, 0% residual voltage for 0.5 periods	
OTHERS	FLICKER Note.9	PstLM ≤ 1, SVM ≤ 0.4		
	MTBF	4130.5K hrs min. Telcordia SR-332 (Bellcore) 317.7Khrs min. MIL-HDBK-217F (25℃)		
	DIMENSION	176*45*32mm , 136*45*32mm (L*W*H)		
	PACKING	0.32Kg; 40pcs/13.8Kg/0.48CUFT(for XLC-60 Series); 0.39Kg; 40pcs/16.6Kg/0.61CUFT(for XLC-60-S Series);		
NOTE	<ol style="list-style-type: none"> <li>All parameters NOT specially mentioned are measured at 230VAC input, rated current and 25℃ of ambient temperature.</li> <li>De-rating may be needed under low input voltages. Please refer to "STATIC CHARACTERISTIC" sections for details.</li> <li>Length of set up time is measured at first cold start. Turning ON/OFF the driver may lead to increase of the set up time.</li> <li>Current ripple is measured 50%~100% of maximum voltage under rated power delivery.</li> <li>Standby power consumption is measured at 230VAC.</li> <li>The driver is considered as a component that will be operated in combination with final equipment. Since EMC performance will be affected by the complete installation, the final equipment manufacturers must re-qualify EMC Directive on the complete installation again. (as available on <a href="https://www.meanwell.com/Upload/PDF/EMI_statement_en.pdf">https://www.meanwell.com/Upload/PDF/EMI_statement_en.pdf</a>)</li> <li>The ambient temperature derating of 3.5℃/1000m with fanless models and of 5℃/1000m with fan models for operating altitude higher than 2000m(6500ft).</li> <li>To fulfill requirements of the latest ErP regulation for lighting fixture, this LED driver can only be used behind a switch without permanently connected to the mains.</li> <li>Flicker is measured at full load with the light source provided by MEAN WELL.</li> <li>For XLC-S series: RCM is on a voluntary basis. Non IC classification Independent LED control gear is not suitable for residential installations. For XLC(except -S) series: RCM is on a voluntary basis and meets relevant IEC or AS/NZS standards complying with AS/NZS 4417.1.</li> <li>This series meets the typical life expectancy of 50000 hours of operation when Tcase,particularly tc point(or TMP,per DLC), is about 75℃ or less.</li> <li>For more information, please contact with MEAN WELL sales.</li> <li>Products sourced from the China regions and some models sourced from India may not have the BIS logo,please refer to BIS certificate for details and contact your MEAN WELL sales for more information.</li> </ol>			
	<p>※ Product Liability Disclaimer: For detailed information, please refer to <a href="https://www.meanwell.com/serviceDisclaimer.aspx">https://www.meanwell.com/serviceDisclaimer.aspx</a></p>			

**SPECIFICATION**

MODEL	XLC-60-H-□□□			
OUTPUT	OPEN CIRCUIT VOLTAGE <small>Note14</small>	60V		
	DEFAULT CURRENT	1400mA		
	CURRENT ADJ. RANGE (BY DIP SWITCH OR NFC)	0.9~1.7A		
	CONSTANT CURRENT REGION	9~54V		
	RATED POWER	60W		
	CURRENT RIPPLE <small>Note4</small>	<4%		
	CURRENT TOLERANCE	±5%		
	DIMMING RANGE	0~100%		
SETUP,RISE TIME <small>Note12</small>	800ms,100ms/230VAC ,1000ms,100ms/115VAC			
INPUT	VOLTAGE RANGE	100 ~ 305VAC	155 ~400VDC	
	FREQUENCY RANGE	47 ~ 63Hz		
	POWER FACTOR	PF ≥0.95/115VAC, PF ≥0.95/230VAC,PF ≥0.9/277VAC@full load (Please refer to "POWER FACTOR (PF) CHARACTERISTIC" section)		
	TOTAL HARMONIC DISTORTION	THD< 20%(@load ≥60%/230VAC; @load ≥75%/277VAC); THD<10%@load 100%/230VAC (Please refer to "TOTAL HARMONIC DISTORTION(THD)" section)		
	EFFICIENCY(Typ.) <small>Note11</small>	90%		
	AC CURRENT	0.75A/115VAC, 0.35A/230VAC, 0.3A/277VAC		
	INRUSH CURRENT	COLD START 15A(twidth=310µs measured at 50% Ipeak) at 230VAC; Per NEMA 410		
	MAX. NO. of PSUs on 16A CIRCUIT BREAKER	25 units (circuit breaker of type B) / 36 units (circuit breaker of type C) at 230VAC		
	LEAKAGE CURRENT	<0.75mA / 277VAC		
	STANDBY POWER CONSUMPTION <small>Note5</small>	Standby power consumption<0.5W (Dimming off, only for standard version B/DA2-type)		
	PROTECTION	SHORT CIRCUIT	Hiccup mode, recovers automatically after fault condition is removed	
		OVER TEMPERATURE	DA2 type: Stage 1: Derating to 75% loading; stage2: Derating to 50% loading; Recovers automatically after fault condition is removed	
Blank & B type: Derating to lowest output level, Recovers automatically after fault condition is removed				
ENVIRONMENT	WORKING TEMP.	Tcase=-25~90°C (Please refer to "OUTPUT LOAD vs TEMPERATURE" section)		
	MAX. CASE TEMP.	Tcase=90°C		
	WORKING HUMIDITY	20 ~ 90% RH non-condensing		
	STORAGE TEMP., HUMIDITY	-40 ~ +80°C, 10 ~ 95% RH		
	TEMP. COEFFICIENT	±0.03%/°C (0 ~ 50°C)		
	VIBRATION	10 ~ 500Hz, 2G 10min./1cycle, period for 60min. each along X, Y, Z axes		
SAFETY&EMC	SAFETY STANDARDS	UL8750(Class P), CSA C22.2 No. 250.13-12; ENEC BS EN/EN61347-1, BS EN/EN61347-2-13(EL) appendix J suitable for emergency installations(DC input 176-280VDC); BS EN/EN62384 , BIS IS15885(Part2/Sec13)(NOTE 13), GB/T19510.1, GB/T19510.213, EAC TP TC 004 approved; Design refer to AS/NZS 61347-1, AS/NZS 61347-2-13		
	DALI STANDARDS	Comply with IEC62386-101, 102, 207		
	WITHSTAND VOLTAGE	I/P-O/P:3.75KVAC		
	ISOLATION RESISTANCE	I/P-O/P:>100M Ohms / 500VDC / 25°C / 70% RH		
	EMC EMISSION	Parameter	Standard	Test Level/Note
		Conducted	BS EN/EN55015(CISPR15) ,GB/T 17743	-----
		Radiated	BS EN/EN55015(CISPR15) ,GB/T 17743	-----
		Harmonic Current	BS EN/EN61000-3-2 , GB17625.1	Class C @load≥60%
	EMC IMMUNITY	Parameter	Standard	Test Level/Note
		ESD	BS EN/EN61000-4-2	Level 3, 8KV air ; Level 2, 4KV contact
Radiated		BS EN/EN61000-4-3	Level 2	
EFT/Burst		BS EN/EN61000-4-4	Level 2	
Surge		BS EN/EN61000-4-5	Level 3, 1KV/Line-Line	
Conducted		BS EN/EN61000-4-6	Level 2	
Magnetic Field		BS EN/EN61000-4-8	Level 2	
Voltage Dips and Interruptions		BS EN/EN61000-4-11	70% residual voltage for 10 period, 0% residual voltage for 0.5 periods	
OTHERS	FLICKER <small>Note.9</small>	PstLM ≤ 1, SVM ≤ 0.4		
	MTBF	4130.5K hrs min. Telcordia SR-332 (Bellcore)	317.7Khrs min. MIL-HDBK-217F (25°C)	
	DIMENSION	176*45*32mm , 136*45*32mm (L*W*H)		
	PACKING	0.32Kg; 40pcs/13.8Kg/0.48CUFT(for XLC-60 Series);	0.39Kg; 40pcs/16.6Kg/0.61CUFT(for XLC-60-S Series);	
NOTE	<ol style="list-style-type: none"> <li>All parameters NOT specially mentioned are measured at 230VAC input, rated current and 25°C of ambient temperature.</li> <li>De-rating may be needed under low input voltages. Please refer to "STATIC CHARACTERISTIC" sections for details.</li> <li>Length of set up time is measured at first cold start. Turning ON/OFF the driver may lead to increase of the set up time.</li> <li>Current ripple is measured 50%~100% of maximum voltage under rated power delivery.</li> <li>Standby power consumption is measured at 230VAC.</li> <li>The driver is considered as a component that will be operated in combination with final equipment. Since EMC performance will be affected by the complete installation, the final equipment manufacturers must re-qualify EMC Directive on the complete installation again. (as available on <a href="https://www.meanwell.com/Upload/PDF/EMI_statement_en.pdf">https://www.meanwell.com/Upload/PDF/EMI_statement_en.pdf</a>)</li> <li>The ambient temperature derating of 3.5°C/1000m with fanless models and of 5°C/1000m with fan models for operating altitude higher than 2000m(6500ft).</li> <li>To fulfill requirements of the latest ErP regulation for lighting fixture, this LED driver can only be used behind a switch without permanently connected to the mains.</li> <li>Flicker is measured at full load with the light source provided by MEAN WELL.</li> <li>For XLC-S series: RCM is on a voluntary basis. Non IC classification Independent LED control gear is not suitable for residential installations. For XLC(except -S) series: RCM is on a voluntary basis and meets relevant IEC or AS/NZS standards complying with AS/NZS 4417.1.</li> <li>Efficiency is measured at 1050mA/54V output set by DIP switch.</li> <li>Based on IEC 62386-101/102 DALI power on timing and interruption regulations, the set up time needs to test with a DALI controller which can support for DALI power on function, otherwise the start up time will be higher than 0.5 second.</li> <li>Products sourced from the China regions and some models sourced from India may not have the BIS logo,please refer to BIS certificate for details and contact your MEAN WELL sales for more information.</li> <li>Output hiccups under no-load condition.(only for H-type).</li> <li>This series meets the typical life expectancy of 50000 hours of operation when Tcase, particularly tc point (or TMP, per DLC), is about 75°C or less.</li> <li>For more information, please contact with MEAN WELL sales.</li> </ol> <p>※ Product Liability Disclaimer: For detailed information, please refer to <a href="https://www.meanwell.com/serviceDisclaimer.asp">https://www.meanwell.com/serviceDisclaimer.asp</a></p>			

**■ BLOCK DIAGRAM**

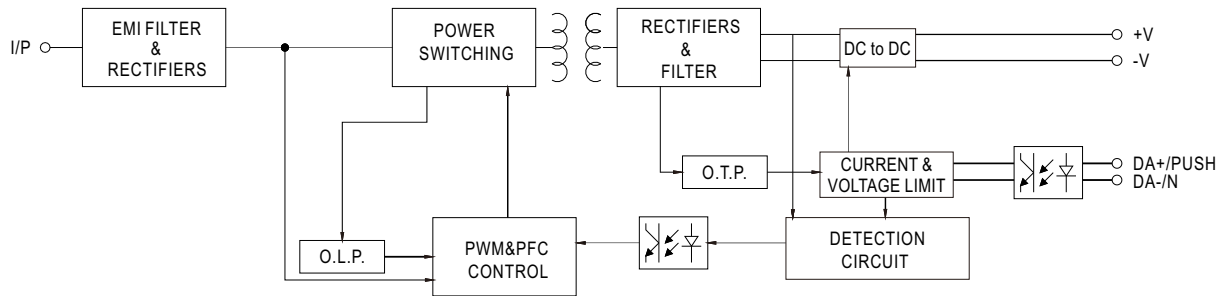

**■ DRIVING METHODS OF LED MODULE**

※ I-V Operating Area

◎ XLC-60-H

For 60W application

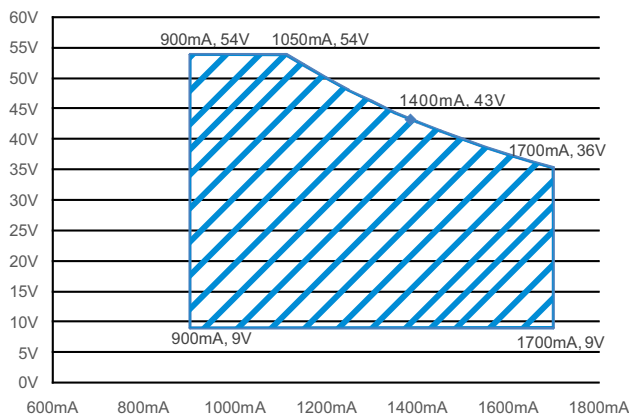

**■ CONSTANT POWER TABLE**

XLC-60-H is a multiple-stage constant power driver, selection of output current through DIP switch or NFC setting is exhibited below.

Vo	Io	DIP S.W		
		1	2	3
9~54V	900mA	---	---	---
9~54V	1050mA	---	---	ON
9~50V	1200mA	---	ON	---
9~46V	1300mA	---	ON	ON
9~43V	1400mA(default)	ON	---	---
9~40V	1500mA	ON	---	ON
9~38V	1600mA	ON	ON	---
9~36V	1700mA	ON	ON	ON

Note: 1. The operating voltage range which show on this table is recommend to use.

**NFC Function Description**

The output current of the NFC Mode LED driver can be adjusted using NFC via the mobile APP

Operation Instruction:

- Compatible phone  
Install an NFC-compatible smart mobile device or phone with Android™ 4.1 or IOS12 updates.
- Steps for setting output current via NFC
  1. Download Meanwell APP on mobile device or mobile phone, and enable NFC function.
  2. Check the NFC antenna position of the mobile phone please.
  3. Enter Meanwell APP ->Top left menu –Installation Manual/APP->PowerNFC, approach the LED driver NFC sensing position and perform sensing.
  4. APP displays the functional parameters, and the relevant parameters are modified as required.
  5. Tap the APP write button and quickly move the phone antenna close to the NFC sensing position of the LED driver.
  6. The write completes when the mobile phone displays"Success".

APP Function Description:

※ APP Interface:

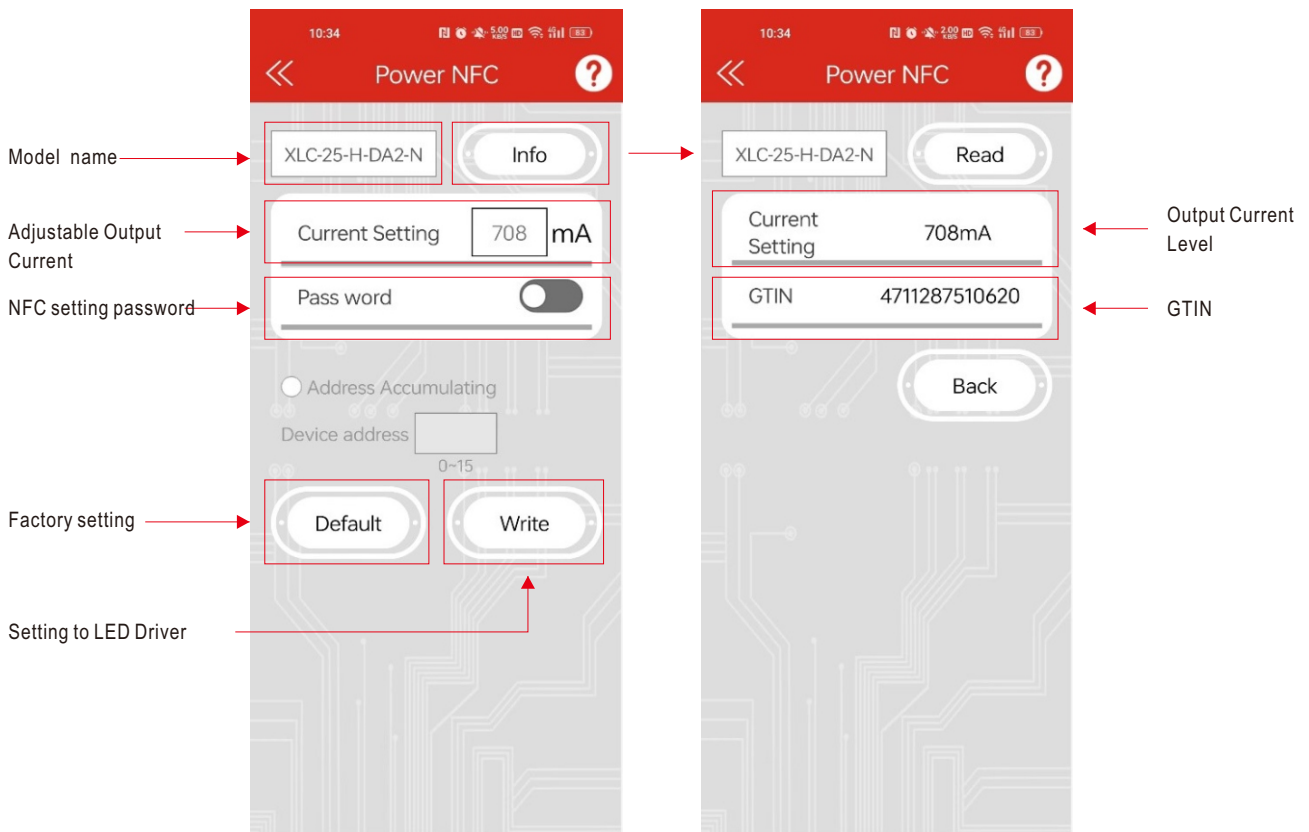

- To be used through APP available on Apple Store and Google Play Store for iOS and Android, Search 'MEAN WELL' on



- Note: 1. Current accuracy : the numerical error between the set current and the actual current is within 2%.  
2. Please turn off the input power supply to the LED driver when using NFC function.

**■ DIMMING OPERATION**

◎ **B type**

※ **3 in 1 dimming function**

- Output constant current level can be adjusted by applying one of the three methodologies between DIM+ and DIM-: 0 ~ 10VDC, or 10V PWM signal or resistance.
- Direct connecting to LEDs is suggested. It is not suitable to be used with additional drivers.
- Dimming source current from power supply: 100  $\mu$ A (typ.)

◎ Applying additive 0 ~ 10VDC

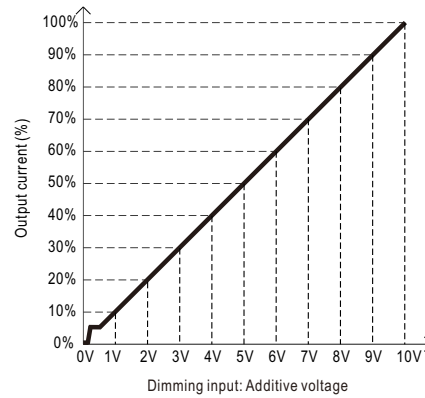
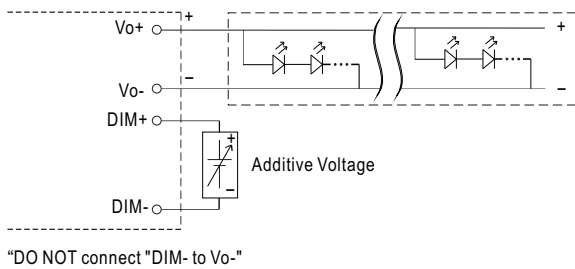

◎ Applying additive 10V PWM signal (frequency range 300Hz~3KHz):

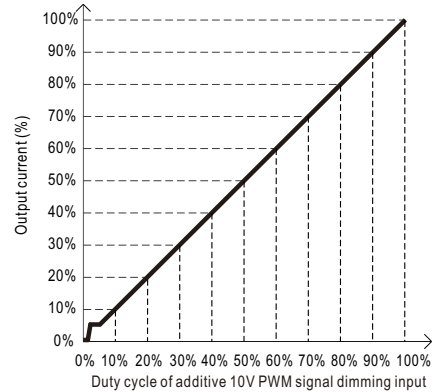
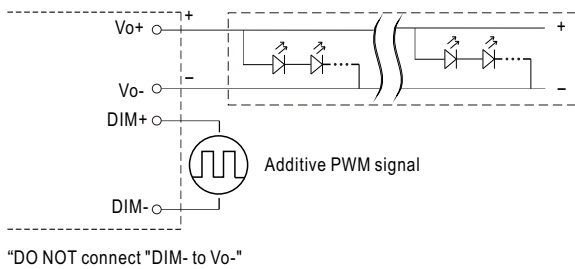

◎ Applying additive resistance: 0~100k  $\Omega$

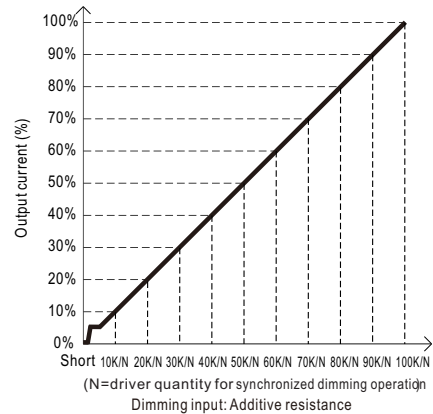
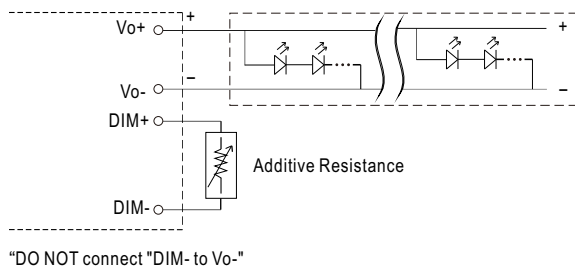

Note : 1. Min. dimming level is about 8% and the output current is not defined when 0% < Iout < 8%.  
 2. The output current could drop down to 0% when dimming input is about 0k $\Omega$  or 0Vdc, or 10V PWM signal with 0% duty cycle.

**■ DIMMING OPERATION**

◎ DA2 type (DALI-2 digital dimming function)

※ Input wiring diagram

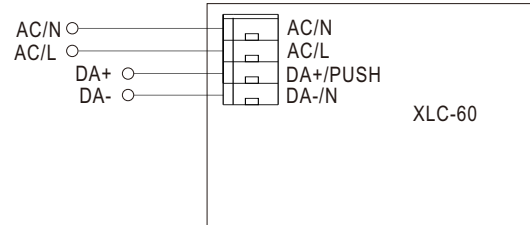
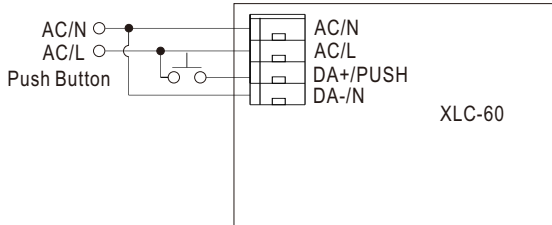

※ PUSH dimming (primary side)

- The factory default dimming level is at 100%.
- If the push action lasts less than 0.05 sec., it will not lead to a change for the status of the driver.
- Up to 10 drivers can perform the PUSH dimming at the same time when utilizing one common push button.
- The maximum length of the cable from the push button to the last driver is 20 meters.

Action	Action duration	Function
Short Push	0.1~1s	Turn ON-OFF the driver
Double Click	Click twice in 1.5s	Set up the dimming level to 100%
Long Push	1.5~10s	Every Long Push changes the dimming direction, dimming up or down

**■ PWM OUTPUT DIMMING PRINCIPLE**

※ For 12V/24V/48V PWM style output dimming

- Dimming is achieved by varying the duty cycle of the output current.

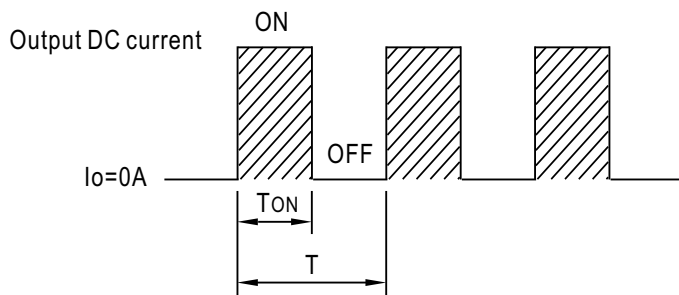

$$\text{Duty cycle(\%)} = \frac{T_{ON}}{T} \times 100\%$$

Output PWM frequency :  
 4kHz for B-Type fixed (Typ.)  
 3.2kHz for DA2-Type fixed (Typ.)

**OUTPUT LOAD vs TEMPERATURE**

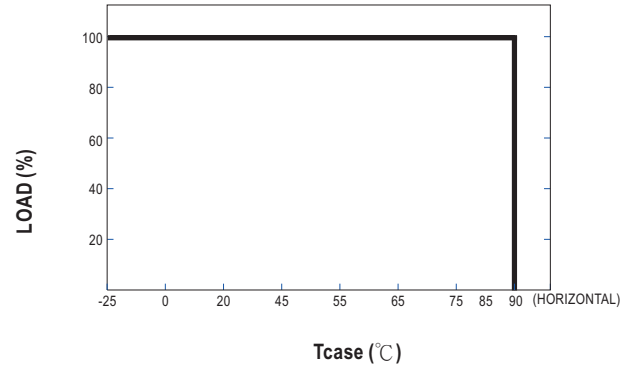
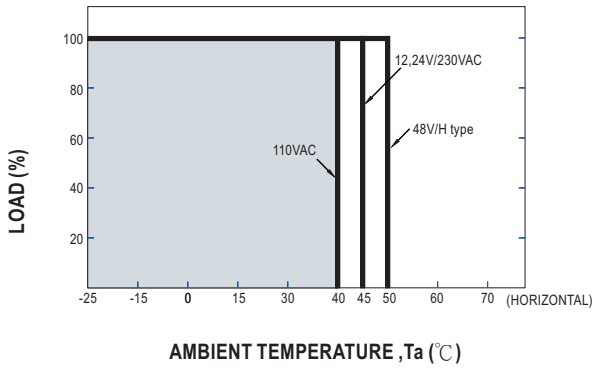

**STATIC CHARACTERISTIC**

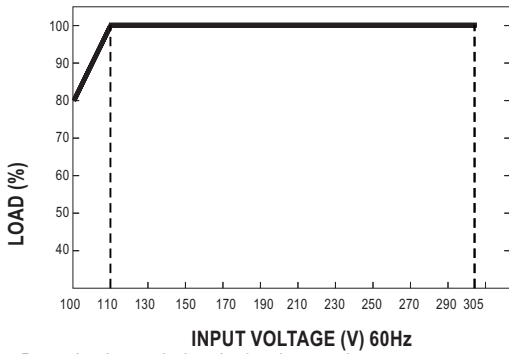

※ De-rating is needed under low input voltage.

**LIFE TIME**

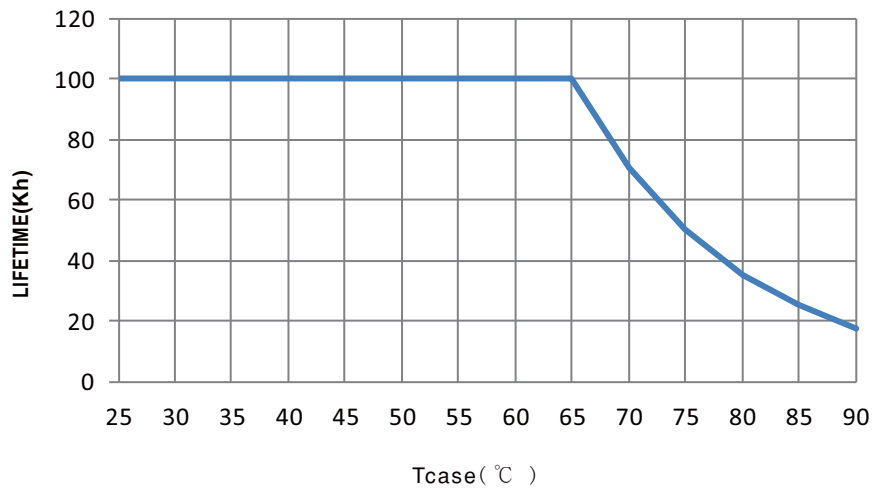



**TOTAL HARMONIC DISTORTION (THD)**

※ Tcase at 75°C

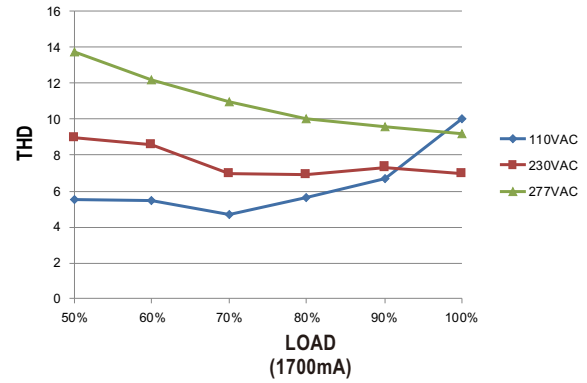
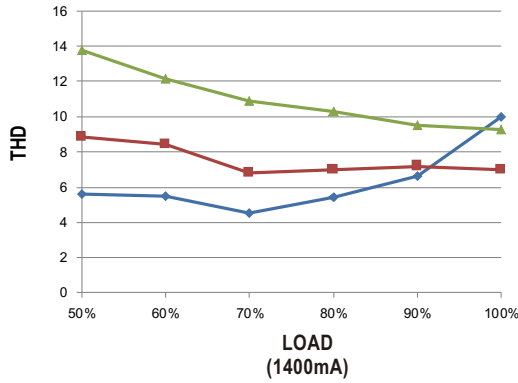

**POWER FACTOR (PF) CHARACTERISTIC**

※ Tcase at 75°C

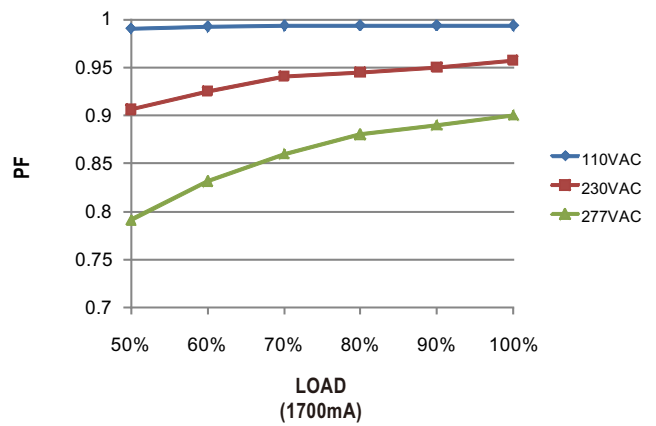
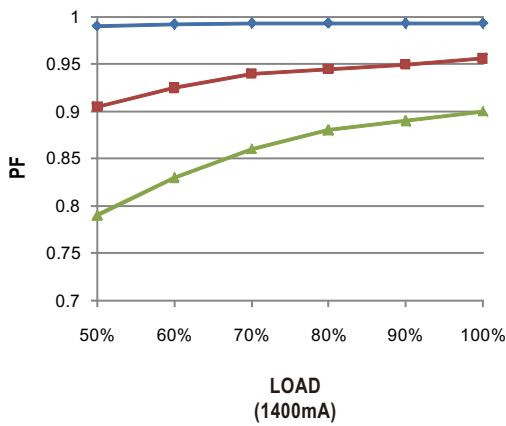

**EFFICIENCY vs LOAD**

XLC-60 series possess superior working efficiency that up to 89% can be reached in field applications.

※ Tcase at 75°C

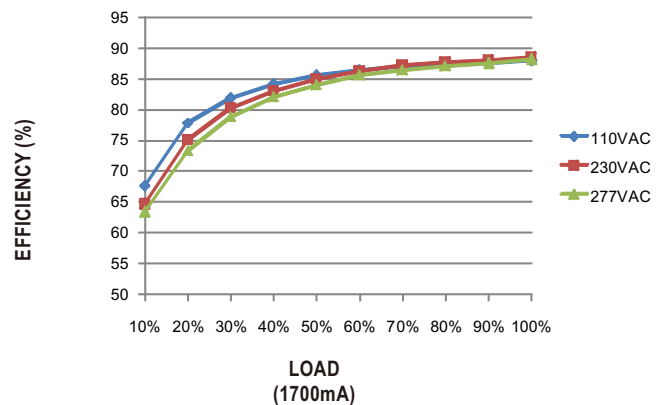
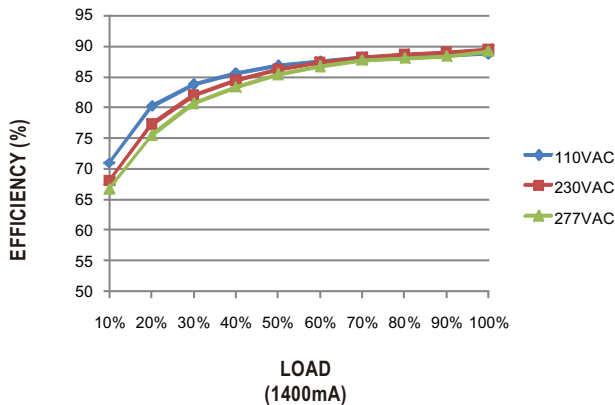

**MECHANICAL SPECIFICATION**

(XLC-60 Built-in Type)

Case No.XLC-60

Unit:mm

Tolerance:±1

※ Blank type

※ Terminal Pin No. Assignment( TB1)

Pin No.	Assignment
1	AC/N
2	AC/L

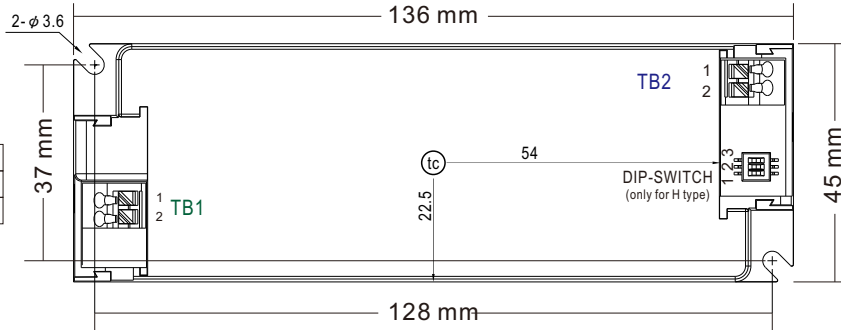

※ Terminal Pin No. Assignment(TB2)

Pin No.	Assignment
1	+V
2	-V

※ B type

※ Terminal Pin No. Assignment( TB1)

Pin No.	Assignment
1	AC/N
2	AC/L

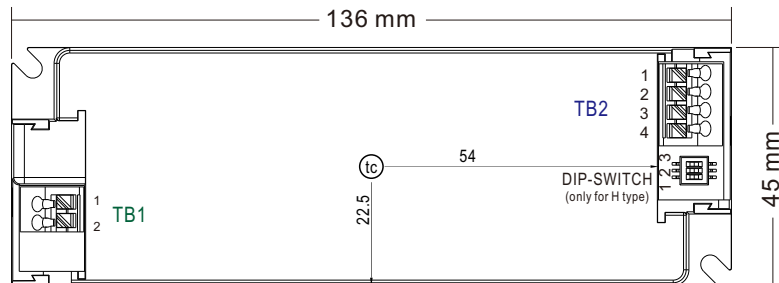

※ Terminal Pin No. Assignment(TB2)

Pin No.	Assignment
1	+V
2	-V
3	DIM+
4	DIM-

※ DA2 type

※ Terminal Pin No. Assignment( TB1)

Pin No.	Assignment
1	AC/N
2	AC/L
3	DA+/PUSH
4	DA-/N

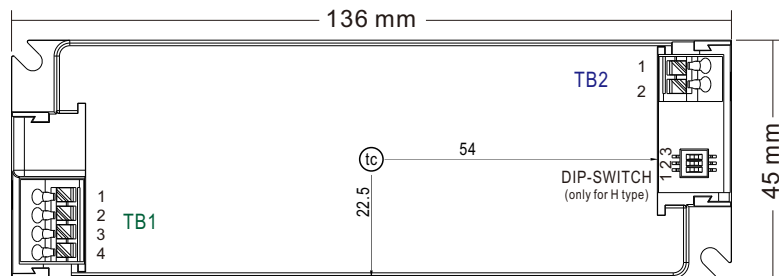

※ Terminal Pin No. Assignment(TB2)

Pin No.	Assignment
1	+V
2	-V

**TB1 wiring:**

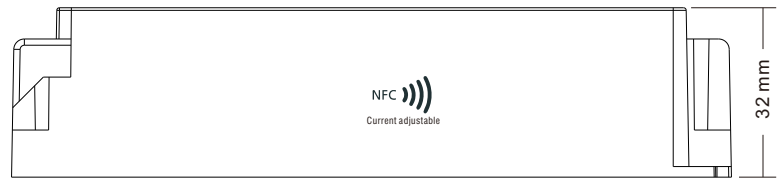
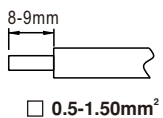

**TB2 wiring:**

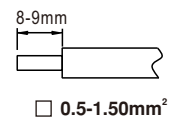

Item	Order No.	Quantity(MOQ/1Bag)
Strain-relief cap	1**XLC-SET	50pcs (2pcs 1 set)

**MECHANICAL SPECIFICATION**

(XLC-60-S Independent Type)

Case No. XLC-60-S

Unit:mm

Tolerance:±1

※ Blank type

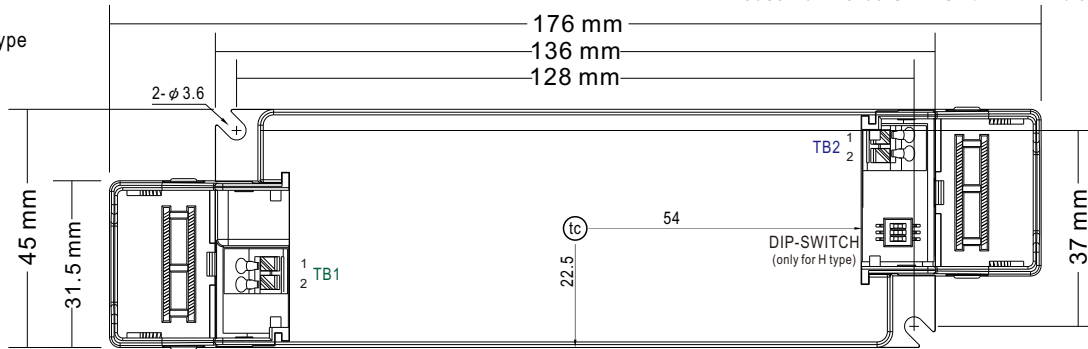

※ Terminal Pin No. Assignment (TB1)

Pin No.	Assignment
1	AC/N
2	AC/L

※ Terminal Pin No. Assignment (TB2)

Pin No.	Assignment
1	+V
2	-V

※ B type

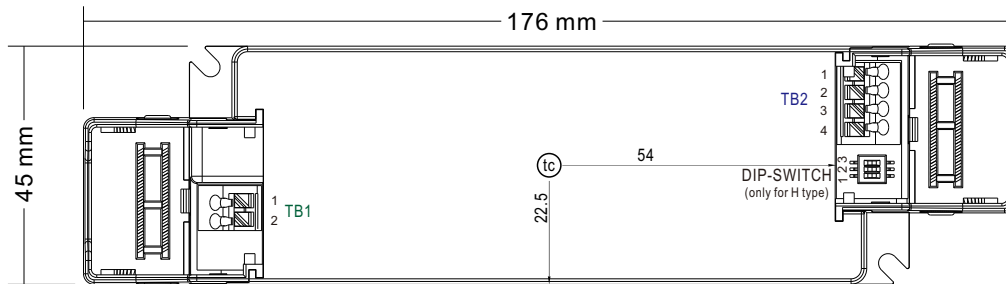

※ Terminal Pin No. Assignment (TB1)

Pin No.	Assignment
1	AC/N
2	AC/L

※ Terminal Pin No. Assignment (TB2)

Pin No.	Assignment
1	+V
2	-V
3	DIM+
4	DIM-

※ DA2 type

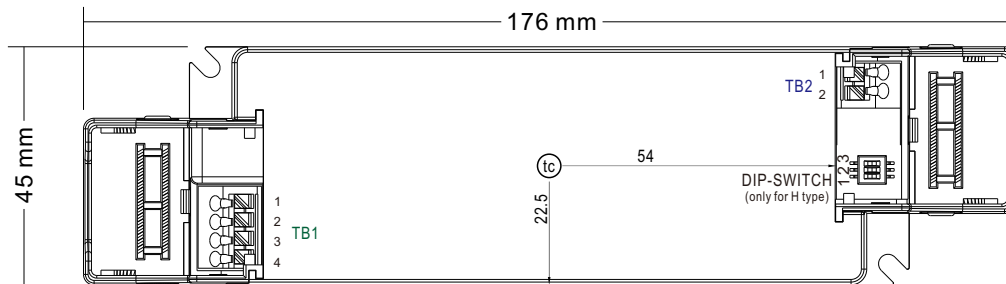

**TB1 wiring:**

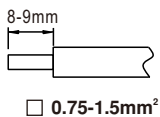

※ Terminal Pin No. Assignment (TB1)

Pin No.	Assignment
1	AC/N
2	AC/L
3	DA+/PUSH
4	DA-/N

※ Terminal Pin No. Assignment (TB2)

Pin No.	Assignment
1	+V
2	-V

**TB2 wiring:**

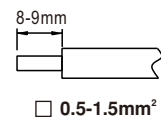

**Installation Manual**

Please refer to : <http://www.meanwell.com/manual.html>